

Solbjerg

BELLOTA AGRISOLUTIONS

SOLBJERG IN THE WORLD

SOLBJERG IN DER WELT

SOLBJERG DANS LE MONDE

SOLBJERG I VERDEN

SOLBJERG Solbjerg is a recognised brand for its large range of components for cultivators. Since 1995 is part of the **BELLOTA GROUP**. Nowadays, Bellota Agrisolutions is the leading company in the world providing agricultural machinery components for soil preparation, seeding and sugar cane harvesting.

SOLBJERG ist eine aufgrund ihres umfangreichen Angebots an landwirtschaftlichen Geräten bekannte Marke. Seit 1995 gehört sie zur Unternehmensgruppe **BELLOTA**. Gegenwärtig ist Bellota Agrisolutions das weltweit führende Unternehmen in der Lieferung von Komponenten für Landwirtschaftsmaschinen zur Bodenvorbereitung, Saatbestellung und Zuckerrohrernte.

SOLBJERG Solbjerg est une marque reconnue pour sa gamme très étendue de composants pour cultivateurs. Depuis 1995, Solbjerg fait partie du **GROUPE BELLOTA**. De nos jours, Bellota Agrisolutions est le leader mondial de composants pour machines agricoles pour la préparation du terrain, le semis et la récolte de sucre de canne.













SOLBJERG er et anerkendt varemærke, der er kendt for sit store sortiment af komponenter og sliddele til harver. Siden 1995 har det været en del af **BELLOTA GROUP** Spanien. I dag er Bellota Agrisolutions den største og førende virksomhed i verden der leverer komponenter samt sliddele til alle førende maskinproducenter til jordbearbejdning, såning og høst af sukkerrør.























INDEX / INDICE / INHALTSANGABE / INDEKS







■ S-Tines / Dents flexibles / S-Zinken / S-Tænder	4
■ Track looseners / Séparateurs de guidage / Spurlockererzinken / Spørløsnere	8
■ Points / Socs dents flexibles / Kulturschare / Kulturharvespidser	9
■ Stubble tines / Dents rigides / Stoppelzinken / Stubtænder	13
■ Stubble points / Socs dechaumeurs / Stoppelschare / Stubspidser	14
■ BELLOTA points / Socs BELLOTA BELLOTA kulturschare / BELLOTA kulturharvespidser	18
■ Parts for stubble cultivation / Pièces de déchaumage Teile für stoppelbearbeitung / Dele til stub-bearbejdning	20
■ Leveling tines / Dents de nivellement / Schleppzinken / Efterharvetænder	22
■ Following tines / Griffes de semoir / Striegelzinken / Strigler	24
■ Reaming springs without grinding / Ressorts rectifiés et non meulés Geschliffen druckfedern ohne feinschliff / Trykfjedre slebne	26
■ Bolt, countersunk head with square neck / Boulons, tête fraisée collet carré Senkschrauben mit vierkantsansatz / Plovbolte	26
■ Bolt, conical head with square neck / Boulons, tête conique collet carré Schrauben, konischer kopf mit vierkantsansatz / Radrenserbolte	27
■ Clamps / Brides / Halter / Spændestykker	28
■ Tines with points / Dents avec socs Zusammengehörigkeitschare / Stænder med spidser	30

S-TINES / DENTS FLEXIBLES
S-ZINKEN / S-TÆNDER

	1.01037.110	1.01020.010	1.01017.010	1.01019.012	1.01029.011	1.01018.010	1.01022.012
							
A	20x6.5	26x8	26x8	26x8	26x8	26x10	26x10
B	225	265	268			268	
C	294	353	357			358	
D	114	151	149	151	151	153	152
E	9	11	11	11	11	11	11
F				262	242		264
				352	332		354
	565	1.022	1.147	1.184	1.204	1.404	1.428
	1.760	768	768	768	768	768	768
				2.10190.051	2.10191.051		2.10190.051
M				M8	M10		M10
	DOUBLET RECORD						
F	100	100	100	100	100	200	100







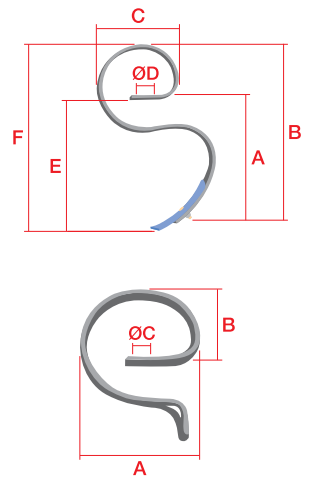





	1.01221.013	1.01075.013	1.01504.013	1.01504.014	1.01504.015	1.01101.011	1.01148.013
							
A	32x10	32x10	32x10	32x10	32x10	32x10	32x10
B							
C	240	213	230	230	230	234	228
D	11	13	13	13	13	13	13
E	455	401	398	404	404	422	424
F	602	545	543	549	549	568	570
							
	2.774	3.075	2.583	2.446	2.446	2.874	2.700
	288	288	288	288	288	288	288
	2.10406.064	2.10130.061	2.15001.061	2.10406.064	2.10406.061	2.10145.061	2.10130.061
M	M10	M10	M10	M10	M10	M10	M10
						KVERNELAND	
F		200	200	200	200		













1.01132.012	1.09036.010	1.09048.010	1.01058.010	1.01070.010	1.01070.013	1.01070.018	1.01043.011
							
26X10	32x8	32x8	32X10	32x10	32x10	32x10	32X10
	203	208	194	344			
			316	490			
153	186	186	194	228	228	228	196
11	13	13	13	13	13	13	14
306					397	392	303
397					543	538	406
1.441	1.265	1.071	2.695	2.695	3.075	3.065	1.909
600	912	864	336	288	288	288	400
2.10341.050					2.10130.061	2.10138.041	2.10156.051
M8			M10	M10	M10	M10	M10
	HELPER S. 101070010/3/8	HELPER S. 101504014/5		STANDARD			GERMINATOR
100	100	100	100			200	

1.01194.314	1.01072.010	1.01072.013	1.01506.010	1.01506.013	1.01054.010
					
32X10,5	32x12	32x12	32x12	32x12	32x12
	345		348		452
	491		478		609
223	230	230	227	227	265
13	13	13	13	13	13
414		397		453	
568		543		583	
3.219	3.215	3.595	2.813	3.193	3.659
324	288	288	288	288	192
2.10130.064		2.10130.061		2.15001.061	
M10	M10	M10	M10	M10	M10
POINT-BALL	STANDARD		JACKPOT	JACKPOT	HIGH CLEARANCE
	200	200	200		200



S-TINES / DENTS FLEXIBLES
S-ZINKEN / S-TÆNDER

	1.01054.013	1.01107.010	1.01107.019	1.01044.012	1.01399.313	1.01159.012	1.01199.010
							
A	32X12	32x12	32X12	32X12	32x12	32x12	32X12
B		478					351
C		608					507
D	265	219	219	232	227	232	227
E	13	13	13	13	14	13	13
F	501		532	380	395	424	
	658		662	528	525	572	
		28	28				
	4.039	3.229	3.569	2.930	3.135	2.300	3.336
	192	250	288	288	288	288	288
	2.10130.061		2.10410.081	2.15001.061	2.10130.061	2.10130.061	
M	M10	M10	M10	M10	M10	M10	M10
	HIGH CLEARANCE	LILLA HARRIE	LILLA HARRIE		SUPER Q		
F	200	100	100	200	200	200	200







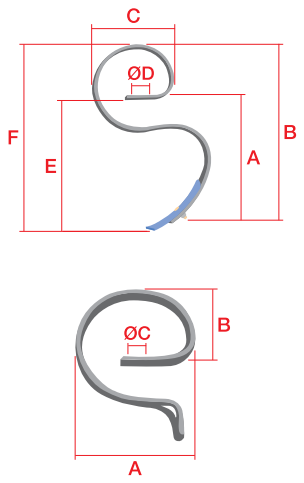





	1.01061.010	1.01061.017	1.01061.018	1.01245.011	1.01085.010	1.01485.010	1.01495.010
							
A	45x12	45X12	45X12	45X12	65x10	65x12	65x13
B	456				451	451	451
C	609				602	604	604
D	258	258	258	236	254	259	261
E	13	13	13	13	13	13	13
F		524	529	415			
		677	682	565			
							
	5.135	5.595	5.715	4.576	6.340	7.627	8.235
	160	160	160	240	120	120	120
		2.10145.062	2.10137.061	2.10145.061			
M	M12	M12	M12	M10	M12	M12	M12
	HEAVY DUTY	HEAVY DUTY	HEAVY DUTY		TOP LINE	TOP LINE	
F		200	200	200	200	200	200



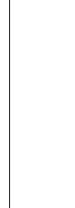







1.01222.011	1.01199.314	1.01135.011	1.01516.013	1.01507.010	1.01507.013	1.01507.014	1.01111.010
32x12	32X12,4	45x9,5	45X10	45x12	45x12	45X12	45x12
				348			448
				478			601
	227	232	223	227	227	227	258
	13	13	13	13	13	13	13,5
455	414	426	450		450	450	
604	570	572	578		580	580	
	3.716	3.760	3.778	4.056	4.436	4.556	4.816
	288	240	240	240	240	240	160
210406064	2.10130.064	2.10145.061	2.15001.061		2.15001.061	2.15001.081	
	M10	M10	M10	M10	M10	M10	M12
	POINT-BALL	KVERNELAND	JACKPOT	JACKPOT	JACKPOT	JACKPOT	CONSER
	200		200	200		200	100

2489 C2A	2489-C2A-35
70X12	70X12
505	
667	
292	292
15	15
	576
	738
45	45
8.950	9.950
90	90
	15035-CA
M10	M10



TRACK LOOSENERS / SÉPARATEURS DE GUIDAGE SPURLOCKERERZINKEN / SPORLØSNER

	1.05045.011	1.05010.014	1.05023.014	1.05025.010	1.05025.014	1.05015.013	1.50150.010
							
B	25X25	32X10	32X10	32x10	32x10	32X10	32X10
D	200	174	178	178	178	165	126
E	13					13	13X25
	817	597	656	582	657	795	487
	27,5	28	28	28	28		
	10.000	2.426	2.801	2.240	2.600	2.548	1.371
	30	414	396	396	396	280	510
	2.10411.206	2.10412.081	2.10412.081		2.10412.081	2.10130.061	
M	M10	M10	M10	M10	M10	M10	M12
F		NORDSTEN	FIONA				Helper 1.05015.013
F	100	100	100	100	100	100	100

	1.50110.010	1.05012.013	1.50120.010	1.05049.013	1.50490.010
					
B	40X10	40X10	40x10	40X14	40x12
D	145	165	126	274	450
E	13X25	13	13X25	13	98
	525	795	485	791	489
					
	1.783	3.111	1.723	4.121	2.520
	500	280	600	240	576
		2.10130.061		2.10130.061	
M	M12	M10	M12	M10	M12
F	Helper 1.05011.013		Helper 1.05012.013		Helper 1.05049.013
F	100			100	100

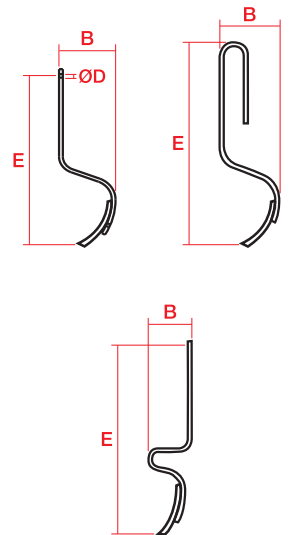

1.05018.014	1.05044.011	1.50034.010	1.05004.013	1.50040.010	1.05022.013	1.50220.010	1.05011.013
32x10	32X10	32X10	32x12	32x12	32X12	32x10	40X10
167	170	134	184	137	167	126	184
	13	13X25	13	13X25	13	13X25	13
536	580	291	697	440	594	287	780
28							
2.300	1.886	905	2.417	1.408	2.362	891	2.805
414	320	432	300	576	320	576	300
2.10412.081	2.10156.051		2.10130.061		2.10130.061		2.10130.061
M10	M10	M12	M10	M12	M10	M12	M10
		Helper 1.05044.011		Helper 1.05004.013		Helper 1.05022.013	
100	100	100			100	100	100

POINTS / SOCS DENTS FLEXIBLES KULTURSCHARE / KULTURHARVESPIDSER

	2.10190.051	2.10341.051	2.10326.051	2.10412.081	2.10412.083
A	23	25	25	32	32
B	177	135	177	158	158
-I-	5	5	5	8	8
R	R250		R250	R165	R165
				28	28
	155	115	115	350	350
	6.000	5.000	5.000	3.200	3.200
	1		1	1	5
M	M8	M8	M10	M10	M10
				MARSK STIG	MARSK STIG
F		200	200		

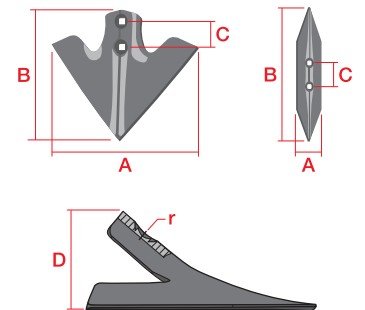





1 Black / Noir / Schwarz / Sort • 2 Silver / Silver / Silver / Sølv / Sort • 3 Green / Vert / Grün / Grøn / Sort • 4 Blue / Bleu / Blau / Blå • 5 Red / Rouge / Rot / Rot

POINTS / SOCS DENTS FLEXIBLES
KULTURSCHARE / KULTURHARVESPIDSER

	2.10410.081	2.10406.064	2.10411.206	2.15001.061	2.10191.051	2.10156.051	2.15001.081
							
A	32	35	35	35	36	36	37
B	160	140	158	218	132	135	218
	8	6	20	6	5	5	8
R	R160	R275	R200		R275		
	28		28				
	340	350	350	380	175	175	500
							
	2.500	10.000	2.500	2.600	5.000	4.500	2.600
	1	4	2	1	1	1	1
M	M10	M10	M10	M10	M10	M10	M10
		MARSK STIG	MARSK STIG	JACKPOT		GERMINATOR	JACKPOT
F					200		200

 1 Black / Noir / Schwarz / Sort • 2 Silver / Silver / Silver / Sølv / Sort • 3 Green / Vert / Grün / Grøn / Sort • 4 Blue / Bleu / Blau / Blå • 5 Red / Rouge / Rot / Röt

	2.10145.062	2.10145.561	2.10003.066	2.10065.061	2.10080.061	2.10063.061	2.10137.061
							
A	40,5	40,5	42	45	45	45	46
B	240	240	206	210	210	223	255
	6	6	6	6	6	6	6
R	R370	R370		R224	R230	R240	R310
			25	45	25	25	
	460	460	400	410	410	380	580
		20					
	2.025	2.000	1.850	2.400	2.400	2.500	2.000
	3	1	2	1	1	1	1
M	M10	M10	M8	M10	M10	M8	M10
	KVERNELAND		MULTIPLEX				
F		200		200	200	200	

 1 Black / Noir / Schwarz / Sort • 2 Silver / Silver / Silver / Sølv / Sort • 3 Green / Vert / Grün / Grøn / Sort • 4 Blue / Bleu / Blau / Blå • 5 Red / Rouge / Rot / Röt

2.10130.061	2.10130.062	2.10130.064	2.10130.081	2.10130.524	2.10130.622	2.10130.682	2.10145.061
38	38	38	38	38	38	38	40,5
210	210	210	210	210	210	210	240
6	6	6	8	6	6	8	6
R275	R275	R275	R275	R275	R275	R275	R370
380	380	380	500	414	420	500	460
				25	25		
2.600	2.600	2.600	2.000	2.500	2.500	1.875	2.025
1	3	4	1	4	3	3	1
M10	M10	M10	M10	M10	M10	M10	M10
STANDARD	STANDARD	STANDARD	STANDARD	STANDARD			
	200	200		200	200	200	

2.10158.151	2.10137.081	2.10137.101	2.10062.061	2.10135.061	2.10135.064
47	48	48	50	70	70
255	255	255	226	152	152
15	8	10	6	6	6
R310	R310	R310	R192	R400	R400
			22-44		
1.250	770	975	500	390	390
500	1.200	1.000	2.250	2.000	2.000
1	1	1	1	1	4
M12	M12	M12	M8	M12	M12
				2 1/2" ULTRA	2 1/2" ULTRA
200		100	200	200	200

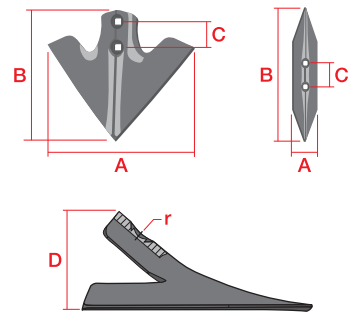

POINTS / SOCS DENTS FLEXIBLES
KULTURSCHARE / KULTURHARVESPIDSER







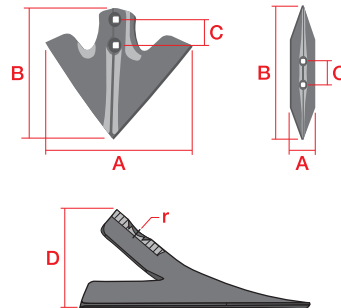

	2.10248.064	2.10132.041	2.10139.041	2.10143.041	2.10323.081	2.10138.041	2.10133.051
A	70	105	107	135	140	158	175
B	152	155	120	170	190	171	156
	6	4	4	4	8	4	5
R	R400		R247	40°	R275	40°	41°
					45		
	390	420	244	440	445	370	390
	2.500	10.000	10.000	2.100	2.750	2.250	10.000
	4	1	1	1	1	1	1
M	M10	M10	M10	M10	M10	M10	M10
	2 1/2" ULTRA	4"	4 1/8"	KONGSKILDE		5"	7"
F	200		200		200		200

1 Black / Noir / Schwarz / Sort • 2 Silver / Silver / Silver / Sølv / Sort • 3 Green / Vert / Grün / Grøn / Sort • 4 Blue / Bleu / Blau / Blå • 5 Red / Rouge / Rot / Röt













	15001-C6	15001-D	15001-D6
A	200	250	250
B	125	125	125
	6	4	6
R	R200	R200	R200
	770	600	900
	1.000	1.100	800
	1	1	1
M	M10	M10	M10
F			



1 Black / Noir / Schwarz / Sort • 2 Silver / Silver / Silver / Sølv / Sort • 3 Green / Vert / Grün / Grøn / Sort • 4 Blue / Bleu / Blau / Blå • 5 Red / Rouge / Rot / Röt

2.10146.051	2.10144.031	1544	15001-A	15001-A6	15001-B	15001-B6	15001-C
							
180	188	105	150	150	175	175	200
166	165	120	125	125	125	125	125
5	3	4	4	6	4	6	4
R405	R203	R200	R200	R200	R200	R200	R200
530	392	270	475	610	490	700	515
		12					
10.000	2.500	1.656	2.000	1.500	1.800	1.200	1.500
1	1	1	1	1	1	1	1
M10	M10	M10	M10	M10	M10	M10	M10
7"	KONGSKILDE						
200							

STUBBLE TINES / DENTS RIGIDES
STOPPELZINKEN / STUBTÆNDER

	1.04016.010	1.04001.010	1.04005.010	1.06023.010	1.06046.010	1.06073.010
						
	25x25	30x30	35x35	60x25	60x25	60x25
A	Ø150	Ø150	Ø150			
B	613	613	630	780	794	861
C				325	78	122
D						
	45	45	45	80	80	45
						
	11.140	16.000	22.000	11.142	10.170	10.170
	50	40	30	1.000	80	100
						
M	M12	M12	M12	M12	M12	M12
				MAMMUTH	JUMBO	
F	100	100	100	100	100	100

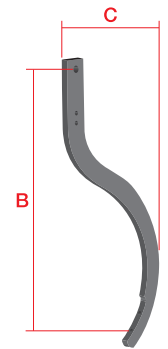

STUBBLE TINES / DENTS RIGIDES
STOPPELZINKEN / STUBTÆNDER

	1.04072.113	1.40202.010	1.40203.010	1.04030.010	1.04030.013	1.04030.014	1.04047.015
	150X10 / 50X13	150X10	50x13	150X10 / 50X12	150X10 / 50X12	150X10 / 50X12	150X10/ 50X12
A	160	160		178	178	178	178
B	565		329	498	498	498	627
C	13			13	13	13	13
D	269	269		309	309	309	309
	45	45	45	45	45	45	45
	50X50	50X50		80X80	80X80	80X80	80X80
	14.065	10.527	2.867	14.860	16.180	16.590	17.000
	48	96	400	48	48	48	48
	2.40004.084				2.40004.061	2.40005.061	2.40005.081
M	M12	M16	M12	M12	M12	M12	M12
	VF	VF	VF	DAVID	DAVID	DAVID	DAVID
F	100				20	20	

STUBBLE POINTS / SOCS DECHAUMEURS
STOPPELSCHARE / STUBSPIDSER

	2.40078.081	2.40075.082	2.40060.082	2.40063.106	2.60316.196	2.60316.596	2.60317.196
A	50	65	65	65	70	70	70
B	252	248	256	311	320	320	320
	8	8	8	10	10	10	10
R	R210	R210	R185	R210	R310	R310	R310
	45	45-60	37.5-52	37.5-52	42-56	42-56	42-56
	735	950	1.000	1.500	1.670	1.670	1.670
						10	
	1.200	1.300	1.200	800	700	440	700
	1	3	3	2	2	2	2
M	M12	M12	M12	M12	M12	M12	M12
			MF		SOLBJERGSYSTEM	SOLBJERGSYSTEM	SOLBJERGSYSTEM
F	200	200				200	

1 Black / Noir / Schwarz / Sort • 2 Silver / Silver / Silver / Sølv / Sort • 3 Green / Vert / Grün / Grøn / Sort • 4 Blue / Bleu / Blau / Blå • 5 Red / Rouge / Rot / Rødt

1.40300.010	1.40360.010	1.40301.010	1.40218.010	1.04049.010	1.40221.010	1.40222.010
150X10	150x10	50x12	50x12	150X14 / 50X22	150x14	50x22
178	178			182,5	182,5	
		302	379	784		458
		309	347	13		
309	309			319	319	
		45	45	43-69	63	43-69
80X80	80X80			100X100	100X100	
12.419	12.419	2.680	3.105	23.100	17.576	5.826
84	84	400	300	30	60	150
M16/M12	M16/M12	M12	M12	M12	M16/M12	M12
DAVID	DAVID	DAVID	DAVID	GOLIATH	GOLIATH	GOLIATH
	100					

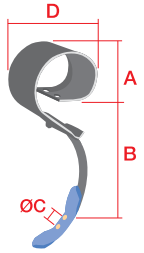

2.60317.596	2.60232.105	2.60237.105	2.60314.131	2.60314.136	2.60315.131
70	70	70	70	70	70
320	410	410	510	510	510
10	10	10	13	13	13
R310	R284	R284	R290	R290	R290
42-56	78	78	37-90	37-90	37-90
1.670	2.400	2.400	3.500	3.500	3.500
10					
440	450	480	350	350	350
2	2	2	1	2	1
M12	M12	M12	M12	M12	M12
SOLBJERGSYSTEM	MAMMUTH	MAMMUTH	LEFT HAND	LEFT HAND	RIGHT HAND
200			200	200	200

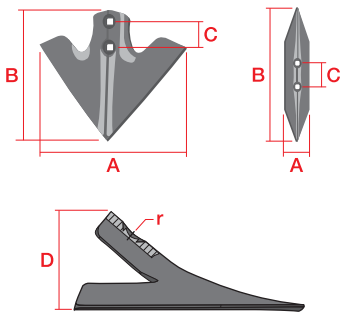









STUBBLE POINTS / SOCS DECHAUMEURS
STOPPELSCHARE / STUBSPIDSER

	2.60315.136	2.40004.061	2.40004.084	2.40004.086	2.40004.584	2.40030.086	2.40121.066
A	70	74	74	74	74	85	85
B	510	262	288	288	288	267	281
	13	6	8	8	8	8	6
R	R290	R230	R230	R230	R230	R85	
	37-90	45	45	45	45		45
	3.500	760	1.160	1.160	760	1.350	1.000
					20		
	350	1.500	1.000	1.000	660	600	650
	2	1	4	2	4	2	2
M	M12	M12	M12	M12	M12	M12	M12
	RIGHT HAND	VIBROFLEX	VIBROFLEX	VIBROFLEX	VIBROFLEX	KVERNELAND	AGRODAN
F	200				200	200	200

1 Black / Noir / Schwarz / Sort • 2 Silver / Silver / Silver / Sølv / Sort • 3 Green / Vert / Grün / Grøn / Sort • 4 Blue / Bleu / Blau / Blå • 5 Red / Rouge / Rot / Røt







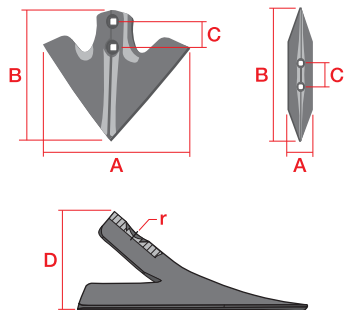





	2.40029.064	2.40029.084	2.60239.066	2.60239.566	2.60261.061	2.60261.064	2.60231.086
A	260	260	308	308	308	308	430
B	225	225	155	155	155	155	260
	6	8	6	6	6	6	8
R							
	45	45	45-55	45-55	45-75	45-75	35-80
	1.425	1.900	1.200	1.200	1.200	1.200	3.450
				10			
	500	500	300	240	300	300	120
	4	4	2	2	1	4	2
M	M12	M12	M12	M12	M12	M12	M12
	KONGSKILDE	KONGSKILDE	SOLBJERGSYSTEM	SOLBJERGSYSTEM			MAMMUTH
F	200	200		200			













1 Black / Noir / Schwarz / Sort • 2 Silver / Silver / Silver / Sølv / Sort • 3 Green / Vert / Grün / Grøn / Sort • 4 Blue / Bleu / Blau / Blå • 5 Red / Rouge / Rot / Røt









2.40085.061	2.40005.061	2.40005.086	2.40005.084	2.40005.584	2.40066.161	2.40028.061	2.40029.061
							
100	110	110	110	110	135	140	260
205	334	334	334	308	453	190	225
6	6	8	8	8	19	6	6
	R196	R198	R198	R190	R310	R150	
30	45	45	45	45	45-75	45	45
810	1.220	1.630	1.630	1.630	3.200	1.350	1.425
650	650	650	650	650	125	10.000	500
1	1	2	4	4	1	1	1
M12	M12	M12	M12	M12	M12	M10	M12
	VIBROFLEX	VIBROFLEX	VIBROFLEX	VIBROFLEX		KONGSKILDE	KONGSKILDE
200		200		200	200		





BELLOTA POINTS / SOCS BELLOTA
BELLOTA KULTUSCHARE / BELLOTA KULTURHARVESPIDSER

	15034 A 10 CA1 420	15034 A 10 CA1 450	15034 B 10 CA1 450	15034 A 10 CA1 480	15034 A 12 CA1 420	15034 B 12 CA1 420	15034 C 12 CA1 420
							
	120x10	120x10	100x10	120x10	120x12	100x12	80x12
							
	10	10	10	10	12	12	12
	3.500	3.950	3.350	4.400	4.250	3.600	2.950
Ref. original							
A	120	120	100	120	120	100	80
B	420	450	450	480	420	420	420
C	45-80/45-80	45-80/45-80	45-80/45-80	45-80/45-80	45-80/45-80	45-80/45-80	45-80/45-80
D							
	200	200	200	200	200	200	250
	1199A	1199A	1199A	1199A	1199A	1199A	1199A
M	M12	M12	M12	M12	M12	M12	M12
F							

	15029-E9	15029-F10	15041-C7-E8	15041-E9-E8	15041-G11-E8	15041-H12-E8	15042-A4-E6
							
	47°	47°	47°	47°	47°	47°	50°
	6-7,5	6-7,5	8	8	8	8	6
	1.520	1.620	1.750	2.000	2.350	2.500	1.500
Ref. original	UWQC9 B/F	UWQC10 B/F	200-PWV-0708	200-PWV-0908	200-PWV-1108	200-PWV-1208	410-PWV-0400
A	228	254	180	228	280	305	102
B	220	220					
C							
D	100	100	125	125	125	125	158
	400	350	350	300	250	225	400
							
M							
	Nichols	Nichols	Bourgault	Bourgault	Bourgault	Bourgault	Bourgault
F	200	200					

15034 A 12 CA1 450	15034 B 12 CA1 450	15034 A 12 CA1 480	15034 B 12 CA1 480	15034 C 12 CA1 480	15034 A 14 CA1 480	15029-C7	15029-D8
							
120x12	100x12	120x12	100x12	80x12	120x14		
						47°	47°
12	12	12	12	12	14	6-7,5	6-7,5
4.750	4.000	5.250	4.450	3.600	6.150	1.340	1.430
						UWQC7 B/F	UWQC8 B/F
120	100	120	100	80	120	180	203
450	450	480	480	480	480	220	220
45-80/45-80	45-80/45-80	45-80/45-80	45-80/45-80	45-80/45-80	45-80/45-80		
						100	100
175	200	200	200	200	200	500	450
1199A	1199A	1199A	1199A	1199A	1199A		
M12	M12	M12	M12	M12	M12		
						Nichols	Nichols
						200	200

15042-B6-E6	15042-D8-E6	15042-H12-E6
		
50°	50°	50°
6	6	6
1.850	2.150	2.850
410-PWV-0600	410-PWV-0800	410-PWV-1200
152	203	305
158	158	158
350	300	200
Bourgault	Bourgault	Bourgault

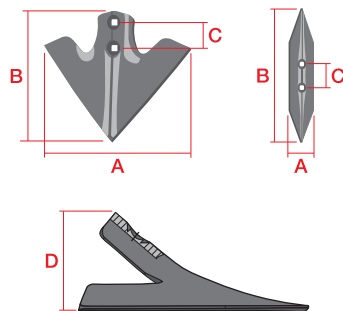

**PARTS FOR STUBBLE CULTIVATION / PIÈCES DE DÉCHAUMAGE
TEILE FÜR STOPPELBEARBEITUNG / DELE TIL STUB-BEARBEJDNING**

	2823-A	2823-B	2823-C	15055-A 80 HRS	15055-B CP 80 HRS DURATOP	15055-B-80-CP-CR HRS DURATOP	15055-B120 HRS
							
Ref. original	34060834	34060835	34060836	34060850	00310915	00311069	34060851
	50x25	60x25	60x25				
				12	15	19	12
	7.700	11.100	12.200	1.500	2.000	3.350	2.300
	100	70	65	500	300	300	300
A				80	80	80	120
B	414	567	665		250	260	
C							
							
				1199A	1199A	1199A	1199A
M				1285A	1285A	1285A	1285A
	Horsch	Horsch	Horsch	Horsch	Horsch	Horsch	Horsch
							



	15057-B 100 I HRS	15058-A 80 D HRS	15058-A 80 I HRS	2446 A12 CA	1595 10 CA	1597-A 8 CA	1597-B 8 CA
							
Ref. original	34060852	34060863	34060862	4653680	4679105	3374395	3374394
	8	8	8	70x22	10	8	8
							
	2.700	1.200	1.200	9.800	2.350	1.850	1.850
	300	400	400	100	125	400	250
A	100	80	80	875	150	100	100
B				90	194	295	290
C	57	57	57	45	40/70		
							
	1199A	1199A	1199A		1199A	1199A	1199A
M	1285A	1285A	1285A	M12	M12	M12	M12
	Horsch	Horsch	Horsch		Lemken	Lemken	Lemken
				50			

15056-A D HRS	15056-A I HRS	15056-B D HRS	15056-B I HRS	15057-A 80 CENTRAL	15057-A 80 D HRS	15057-A 80 I HRS	15057-B 100 D HRS
							
34060857	34060856	34060855	34060854		34060859	34060858	34060853
10	10	10	10	8	8	8	8
1.700	1.700	1.250	1.250	1.385	1.950	1.950	2.700
300	300	400	400	200	300	300	300
172,5	172,5	101	101	80	80	80	100
				305			
					57	57	57
HEX	HEX	HEX	HEX	1199A	1199A	1199A	1199A
M12	M12	M12	M12	M12	1285A	1285A	1285A
Horsch	Horsch	Horsch	Horsch		Horsch	Horsch	Horsch

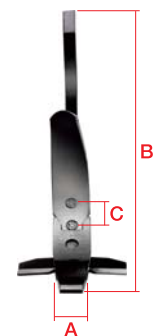













1598 8 D CA	1598 8 I CA	1515 10 CA	1515 12 CA	1515 12 CA AP2 DURATOP	1515 12 B CA
					
3374398	3374399	3374388	3374392	3374392	3374386
8	8	10	12	12	12
2.400	2.400	1.740	2.050	2.250	1.550
300	300	500	500	450	500
110	110	120	120	120	80
300	300	235	235	235	235
1199A	1199A	1199A	1199A	1199A	1199A
M12	M12	M12	M12	M12	M12
Lemken	Lemken	Lemken	Lemken	Lemken	Lemken
					200



**PARTS FOR STUBBLE CULTIVATION / PIÈCES DE DÉCHAUMAGE
TEILE FÜR STOPPELBEARBEITUNG / DELE TIL STUB-BEARBEJDNING**

	1596 10 D CA	1596 10 I CA	1516 10 D CA	1516 11 D CA	1516 11 D CA AP2 DURATOP	1516 10 I CA	1516 11 I CA
							
Ref. original	3374416	3374417	3374418	3374420	3374420	3374419	3374421
	10	10	10	11	11	10	11
	2.100	2.100	2.035	2.635	3.000	2.035	2.635
	450	450	400	370	300	400	370
A	349	349	349	381	380	349	381
B	130	130	130	130	130	130	130
C	70	70	70	70	70	70	70
							
	1199G	1199G	1199G	1199G	1199G	1199G	1199G
M	M12	M12	M12	M12	M12	M12	M12
	Lemken	Lemken	Lemken	Lemken	Lemken	Lemken	Lemken
							





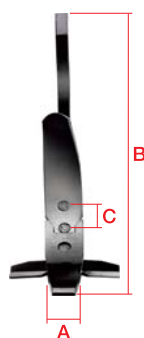

**LEVELING TINES / DENTS DE NIVELLEMENT
SCHLEPPZINKEN / EFTERHARVETÆNDER**

	1.01094.010	1.01095.010	1.01157.010	1.01158.010	1.01160.011	1.01161.011	1.01225.010
							
A	556	556	648	648	523	523	533
B	214	214	315	315	218	218	234
C	408	408			373	373	386
							
					30	30	50
	2.402	2.402	2.191	2.191	3.352	3.352	3.330
	270	270	105	105	250	250	300
					2.10117.000	2.10117.000	
M					M10	M10	M10
L/R	L	R	L	R	L	R	
	100	100	100	100	100	100	

L Left / Gauche / Links / Venstre • R Right / Droite / Rechts / Højre





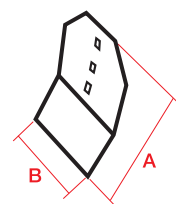
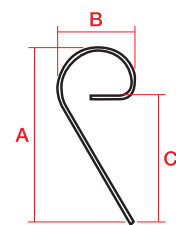

1516 11 I CA AP2 DURATOP	1516B 10 D CA	1516B 10 I CA	1517 CA
			
3374421	3374428	3374429	3374356
11	10	10	5
3.000	1.635	1.635	780
300	400	400	300
380	249	249	256
130	130	130	174
70	70	70	
1199G	1199G	1199G	1199A
M12	M12	M12	M10
Lemken	Lemken	Lemken	Lemken
	200	200	



1.01235.010	1.01295.010	1.01295.013	1.01325.010	1.01134.010	1.01154.010	1.01195.010
						
45x10	45X10	45X10	45X10	60X10	60X10	60X10
408	533	533	364	632	632	609
234	234	234	234	312	312	311
262	386	386	218	453	453	435
50	50-50	50-50	50-50			
2.826	3.330	4.050	2.664	6.426	6.426	6.245
300	300	250	300	75	75	75
		2.10333.101				
M10	M10	M10	M10			M12
				L	R	L
200	200	200	200	100	100	100











LEVELING TINES / DENTS DE NIVELLEMENT
SCHLEPPZINKEN / EFTERHARVETÆNDER

	1.01196.010	1.01363.013	1.01364.013	1.01355.010	1.01375.010	3.09003.101	2.10330.061
							
A	60X10	60X10	60X10	80x10	80X10	32X10	45X6
B	614	632	632	511	411	255	200
C	311	311	311	253	253	220	45
D	435	443	443	360	260	105	6
E							6
F		150	150	45-45	45		50
G	6.245	7.800	7.800	6.050	5.745	2.100	425
H	75	65	65	168	168	400	2.000
I		2.10365.101	2.10365.101				
J	M12	M12	M12	M12	M12	M12	M10
K	R	L	R				
L	100	100	100		200	200	200

L Left / Gauche / Links / Venstre • R Right / Droite / Rechts / Højre

FOLLOWING TINES / GRIFFES DE SEMOIR
STRIEGELZINKEN / EFTERHARVETÆNDER

	2490	2851	2850	2853	2850AB	2852	2854
							
M							
N	2.100	2.100	960	980	150	1.850	1.800
O	230	215	195	195		187	160
P	530	652	440	403		584	436
Q	95	73	66	66		61	52
R	14	20	19	19		14	
S					50x50		
T							
U	500	400	500	500	6.750	400	500
V	100	100	100	100		100	100



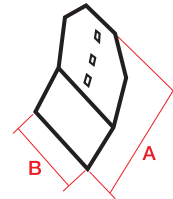
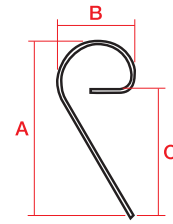

2.10333.101	2.10329.101	2.10117.121	2.10331.101	2.10365.101	2.10355.081
45X10	45X10	45X12	70X10	70X10	150x8
190	200	160	175	250	320
44	45	45	70	70	150
10	10	12	10	10	8
10	10	12	10	10	8
50	50	30	50	150	45-50
685	677	650	1.000	1.374	2.340
1.500	1.500	1.500	1.000	500	400
M10	M10	M10	M10	M12	M12
200	200	200		200	

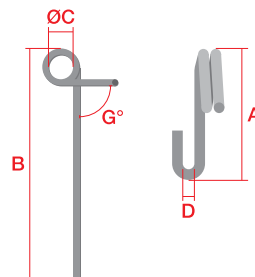





1.16090.495	2855	2855AB	2855AR
16			
2.400	1.200	200	900
332	230		
601	520		
90	96		
19	14		
90			40x40
500			
100	500		
116090495	100		



**REAMING SPRINGS WITHOUT GRINDING / RESSORTS RECTIFIÉS ET NON MEULÉS
GESCHLIFFEN DRUCKFEDERN OHNE FEINSCHLIFF / TRYKFJEDRE SLEBNE**

	2419-A	2420-A	2422-A	2424-I	2424-B	2424-C	2424-G
A	11	12	14	16	16	16	16
B	350	376	300	250	300	300	350
C	48	57	75	98	100	110	65
	23,5	22,5	13	9	11	10	17,5
	1.970	2.750	3.000	3.600	4.100	4.100	4.130
Kg/mm	13,14	10,84	14,72	15,85	11,64	9,28	34,82
NNN	253	264	175	136	168	152	272
max 	1.130	1.206	1.413	1.569	1.532	1.369	2.626
max NNN	86	111	96	99	132	147	75
	400	310	225	200	100	90	310

**BOLT, COUNTERSUNK HEAD WITH SQUARE NECK / BOULONS, TÊTE FRAISÉE COLLET CARRÉ
SENKSCHRAUBEN MIT VIERKANTSANSATZ / PLOVBOLTE**

	1199A-1050	1199A-1150	1199A-1235	1199A-1250	1199A-1285A	1199A-1450
	100	100	100	50	50	50
	800	800	800	400	400	400
DIN	DIN 608	DIN 608	DIN 608	DIN 608	DIN 608	DIN 608
Q 	8.8	8.8	8.8	8.8	10.9	8.8
Q 	.8	.8	.8	.8	.10	.8
ø D	M10	M11	M12	M12	M12	M14
ø D2	17,5	21	24	24	24	28
L	50	50	35	50	85	50

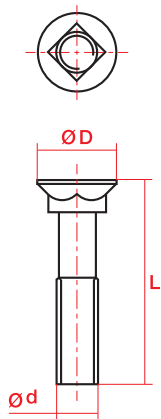

Check the Bellota Catalogue for the whole range.
Consultez la gamme complète dans le Catalogue Bellota.
Prüfen sie den Bellota Katalog für den gesamten Bereich.

	2426-A	2426-B	2426-D	2426-E	2427-A	2430-A	2433-A
	18	18	18	18	19	22	24
	200	250	300	350	150	376	350
	96	101	120	101	89	105	114
	7,75	9,25	9	12,75	6,5	12,5	10,75
	3.510	4.440	5.370	6.150	2.800	9.000	10.800
	35,39	23,69	13,19	16,32	75,99	37,24	49,20
	130,5	157,5	153	220,5	114	264	246
	2.349	2.207	1.796	2.207	3.078	4.030	4.825
	66	93	136	130	36	108	98
	115	85	70	85	200	80	100

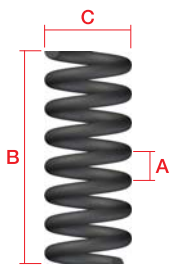





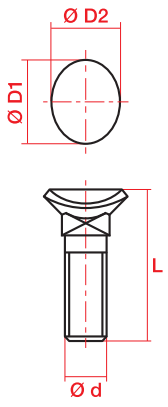





**BOLT, CONICAL HEAD WITH SQUARE NECK / BOULONS, TÊTE CONIQUE COLLET CARRÉ
SCHRAUBEN, KONISCHER KOPF MIT VIERKANTSANSATZ / RADRENSERBOLTE**

	11990-1040	11990-1050	11990-1250	11990-1260
	100	100	50	50
	800	800	400	400
DIN	ISO 5713	ISO 5713	ISO 5713	ISO 5713
	8.8	8.8	8.8	8.8
	.8	.8	.8	.8
ø D	M10	M10	M12	M12
ø D2	18	18	22	22
ø D3	15,5	15,5	19,5	19,5
L	40	50		



CLAMPS / BRIDES
HALTER / SPÆNDESTYKKER

	4.10140.051	4.10220.051	4.10580.061	4.32105.012	4.32105.030	4.32105.050	4.32124.515
							
	20X6,5	25X8	32X10	32X10	32X10	32X10	32X12
	5	5	6	6	6	6	6
	35X12	40X10	40X40	50X12	50X30	50X50	45X15
	200				200	200	200



	4.45125.050	4.45126.060	4.65106.060S	4.65126.060	4.80106.060	4.80107.070
						
	45X12	45x12	65X10	65X12	80X10	80X10
	6	6	10	10	10	10
	50X50	60x60	60X60	60X60	60X60	70X70
				200	60	



4.32125.012	4.32125.030	4.32125.050	4.45105.012	4.45105.050	4.45106.060	4.45116.060	4.45125.012
							
32X10	32X12	32X12	45X10	45X10	45X10	45X10	45X12
6	6	6	6	6	6	6	8
50X12	50X30	50X50	50X12	50X50	60X60	60X60	50X12
200	200		200		200	200	



TINES WITH POINTS / DENTS AVEC SOCS
ZUSAMMENGEHÖRIGKEITSCHARE / TÆNDER MED SPIDSER

9		9	9		9	9		9
1.01017.010			-	2.10117.000	1.01161.011	1.05004.010	2.10130.061	1.05004.013
1.01018.010			-	2.10130.064	1.01194.314	1.05010.010	2.10412.081	1.05010.014
1.01019.010	2.10190.051	1.01019.012	-	2.10130.064	1.01199.314	1.05011.010	2.10130.061	1.05011.013
1.01020.010			1.01195.010			-	2.10130.061	1.05012.013
1.01022.010	2.10190.051	1.01022.012	1.01196.010			-	2.10130.061	1.05015.013
-	2.10191.051	1.01029.011	1.01199.010			-	2.10412.081	1.05018.014
1.01037.110			-	2.10130.064	1.01199.314	-	2.10130.061	1.05022.013
-	2.10156.051	1.01043.011	1.01221.010	2.10406.061	1.01221.013	-	2.10412.081	1.05023.014
-	2.15001.061	1.01044.012	1.01225.010			-	2.10412.081	1.05025.010
1.01054.010			1.01235.010			-	2.10412.081	1.05025.014
1.01054.010	2.10130.061	1.01054.013	1.01245.010	2.10145.061	1.01245.011	-	2.10156.051	1.05044.011
1.01058.010			1.01295.010			-	2.10411.206	1.05045.011
1.01061.010			1.01295.010	2.10333.101	1.01295.013	-	2.10130.061	1.05049.013
1.01061.010	2.10145.062	1.01061.017	1.01325.010			1.06023.010		
1.01061.010	2.10137.061	1.01061.018	1.01355.010			1.06046.010		
1.01070.010			1.01363.010	2.10365.101	1.01363.013	1.06073.010		
1.01070.010	2.10138.041	1.01070.018	1.01364.010	2.10365.101	1.01364.013	1.40202.010		
1.01070.010	2.10130.061	1.01070.013	1.01375.010			1.40203.010		
1.01072.010			-	2.10130.061	1.01399.313	1.40218.010		
1.01072.010	2.10130.061	1.01072.013	1.01485.010			1.40221.010		
-	2.10130.061	1.01075.013	1.01504.010	2.15001.061	1.01504.013	1.40222.010		
1.01085.010			1.01504.010	2.10406.064	1.01504.014	1.40242.010		
1.01094.010			1.01504.010	2.10406.061	1.01504.015	1.40300.010		
1.01095.010			1.01506.010			1.40301.010		
1.01101.010	2.10145.061	1.01101.011	1.01506.010	2.15001.061	1.01506.013	1.40360.010		
1.01107.010			1.01507.010			1.50034.010		
1.01107.010	2.10410.081	1.01107.019	1.01507.010	2.15001.061	1.01507.013	1.50040.010		
1.01111.010			1.01507.010	2.15001.081	1.01507.014	1.50110.010		
1.01132.010			1.01516.010	2.15001.061	1.01516.013	1.50120.010		
1.01132.010	2.10341.050	1.01132.012	1.04001.010			1.50150.010		
1.01134.010			1.04016.010			1.50220.010		
-	2.10145.061	1.01135.011	1.04030.010			1.50490.010		
-	2.10130.061	1.01148.013	1.04030.010	2.40004.061	1.04030.013	2489 C2A		
1.01154.010			1.04030.010	2.40005.061	1.04030.014	2489 C2A	15035-CA-SP	2489C2A35
1.01157.010			-	2.40005.081	1.04047.015			
1.01158.010			1.04049.010					
-	2.10130.061	1.01159.012	1.04052.010	2.10323.081	1.04052.011			
1.01160.010	2.10117.000	1.01160.011	1.04072.110	2.40004.061	1.04072.113			

Ref.	P.
1.01017.010	3
1.01018.010	3
1.01019.012	3
1.01020.010	3
1.01022.012	3
1.01029.011	3
1.01037.110	3
1.01043.011	3
1.01044.012	5
1.01054.010	3
1.01054.013	5
1.01058.010	3
1.01061.010	5
1.01061.017	5
1.01061.018	5
1.01070.010	3
1.01070.013	3
1.01070.018	3
1.01072.010	3
1.01072.013	3
1.01075.013	3
1.01085.010	5
1.01094.010	21
1.01095.010	21
1.01101.011	3
1.01107.010	5
1.01107.019	5
1.01111.010	5
1.01132.012	3
1.01134.010	21
1.01135.011	5
1.01148.013	3
1.01154.010	21
1.01157.010	21
1.01158.010	21
1.01159.012	5
1.01160.011	21
1.01161.011	21
1.01194.314	3
1.01195.010	21
1.01196.010	23
1.01199.010	5
1.01199.314	5
1.01221.013	3
1.01222.011	5
1.01225.010	21
1.01235.010	21
1.01245.011	5
1.01295.010	21
1.01295.013	21
1.01325.010	21
1.01355.010	23
1.01363.013	23
1.01364.013	23
1.01375.010	23
1.01399.313	5
1.01485.010	5
1.01495.010	5
1.01504.013	3

Ref.	P.
1.01504.014	3
1.01504.015	3
1.01506.010	3
1.01506.013	3
1.01507.010	5
1.01507.013	5
1.01507.014	5
1.01516.013	5
1.04001.010	11
1.04005.010	11
1.04016.010	11
1.04030.010	13
1.04030.013	13
1.04030.014	13
1.04047.015	13
1.04049.010	13
1.04072.113	13
1.05004.013	7
1.05010.014	7
1.05011.013	7
1.05012.013	7
1.05015.013	7
1.05018.014	7
1.05022.013	7
1.05023.014	7
1.05025.010	7
1.05025.014	7
1.05044.011	7
1.05045.011	7
1.05049.013	7
1.06023.010	11
1.06046.010	11
1.06073.010	11
1.09036.010	3
1.09048.010	3
1.16090.495	23
1.40202.010	13
1.40203.010	13
1.40218.010	13
1.40221.010	13
1.40222.010	13
1.40300.010	13
1.40301.010	13
1.40360.010	13
1.50034.010	7
1.50040.010	7
1.50110.010	7
1.50120.010	7
1.50150.010	7
1.50220.010	7
1.50490.010	7
2.10003.066	9
2.10062.061	9
2.10063.061	9
2.10065.061	9
2.10080.061	9
2.10117.121	23
2.10130.061	9
2.10130.062	9

Ref.	P.
2.10130.064	9
2.10130.081	9
2.10130.524	9
2.10130.622	9
2.10130.682	9
2.10132.041	11
2.10133.051	11
2.10135.061	9
2.10135.064	9
2.10137.061	9
2.10137.081	9
2.10137.101	9
2.10138.041	11
2.10139.041	11
2.10143.041	11
2.10144.031	11
2.10145.061	9
2.10145.062	9
2.10145.561	9
2.10146.051	11
2.10156.051	9
2.10158.151	9
2.10190.051	7
2.10191.051	9
2.10248.064	11
2.10323.081	11
2.10326.051	7
2.10329.101	23
2.10330.061	23
2.10331.101	23
2.10333.101	23
2.10341.051	7
2.10355.081	23
2.10365.101	23
2.10406.064	9
2.10410.081	9
2.10411.206	9
2.10412.081	7
2.10412.083	7
2.15001.061	9
2.15001.081	9
2.40004.061	15
2.40004.084	15
2.40004.086	15
2.40004.584	15
2.40005.061	15
2.40005.084	15
2.40005.086	15
2.40005.584	15
2.40028.061	15
2.40029.061	15
2.40029.064	15
2.40029.084	15
2.40030.086	15
2.40060.082	13
2.40063.106	13
2.40066.161	15
2.40075.082	13
2.40078.081	13

Ref.	P.
2.40085.061	15
2.40121.066	15
2.60231.086	15
2.60232.105	13
2.60237.105	13
2.60239.066	15
2.60239.566	15
2.60261.061	15
2.60261.064	15
2.60314.131	13
2.60314.136	13
2.60315.131	13
2.60315.136	15
2.60316.196	13
2.60316.596	13
2.60317.196	13
2.60317.596	13
3.09003.101	23
4.10140.051	27
4.10220.051	27
4.10580.061	27
4.32105.012	27
4.32105.030	27
4.32105.050	27
4.32124.515	27
4.32125.012	27
4.32125.030	27
4.32125.050	27
4.45105.012	27
4.45105.050	27
4.45106.060	27
4.45116.060	27
4.45125.012	27
4.45125.050	27
4.45126.060	27
4.65106.060S	27
4.65126.060	27
4.80106.060	27
4.80107.070	27
1199A	25
1199O	25
1515	19
1516	21
1516B	21
1517	21
1544	11
1595	19
1596	21
1597	19
1598	19
2419	25
2420	25
2422	25
2424	25
2426	25
2427	25
2430	25
2433	25
2446	19

Ref.	P.
2489	5
2490	23
2823	19
2850	23
2850AB	23
2851	23
2852	23
2853	23
2854	23
2855	23
2855AB	23
2855AR	23
15001	11
15029	17
15034	17
15041	17
15042	17
15055	19
15056	19
15057	19